

**Díly**

Napojení

Okrajová šňůra

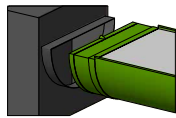

Okrajová šňůra

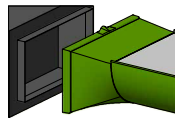

METU rám

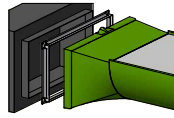

Vstup shora

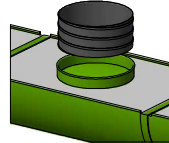

Vstup ve dně

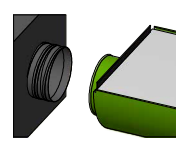

Zavěšení

**FT**

Fasttrack

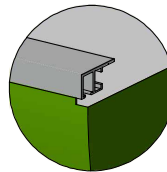
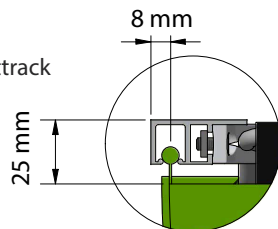

Komponenty

**WR**

Wingrail  
L = 2000 mm

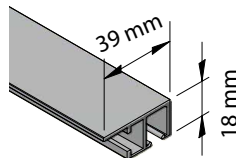

**WC**

Wingrail konektor  
L = 100 mm

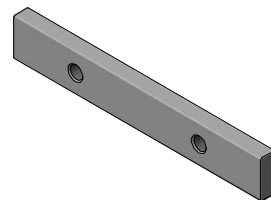

Příslušenství

**F**

Feeder

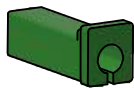

**MC**

Mini Cleat



**QE**

Q-Lux  
koncový  
profil



**SRD** se dnem

(Static Regain Diffuser)



**TC**

Textilní páska

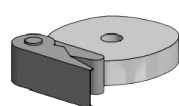

**CL**

Motex  
páska

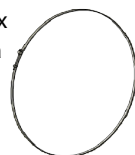

**DE**

D-Lux  
koncový profil



**D-SRD**

(Static Regain Diffuser)



Zakončení

**RB(D)**

Obyčejné dno (D)  
(volitelně tažná šňůra)

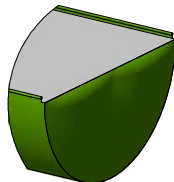

**LB(D)**

Lux dno (D)  
(volitelně tažná šňůra)

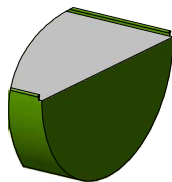

**DLB**

D-Lux dno s tažnou šňůrou

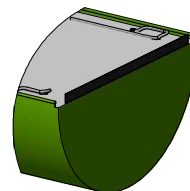

**RB(Q)**

Obyčejné dno (Q)  
(volitelně tažná šňůra)

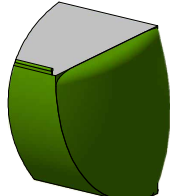

**LB(Q)**

Lux dno (Q)  
(volitelně tažná šňůra)

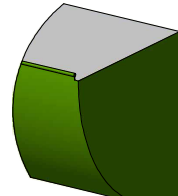

**QLB**

Q-Lux dno s tažnou šňůrou

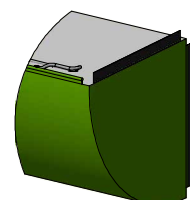

## Instalace půlkruhové/čtvrtkruhové vyústky

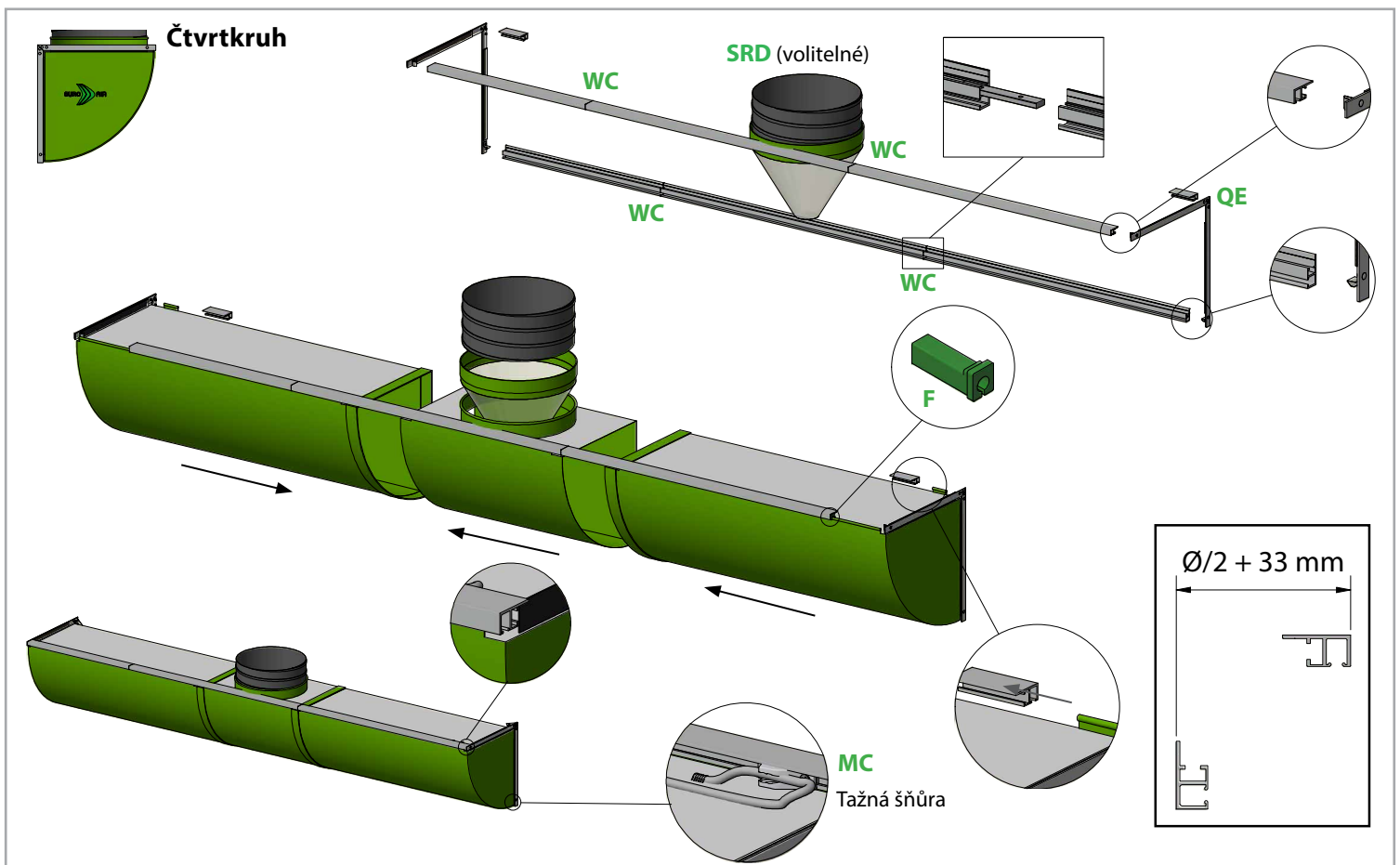
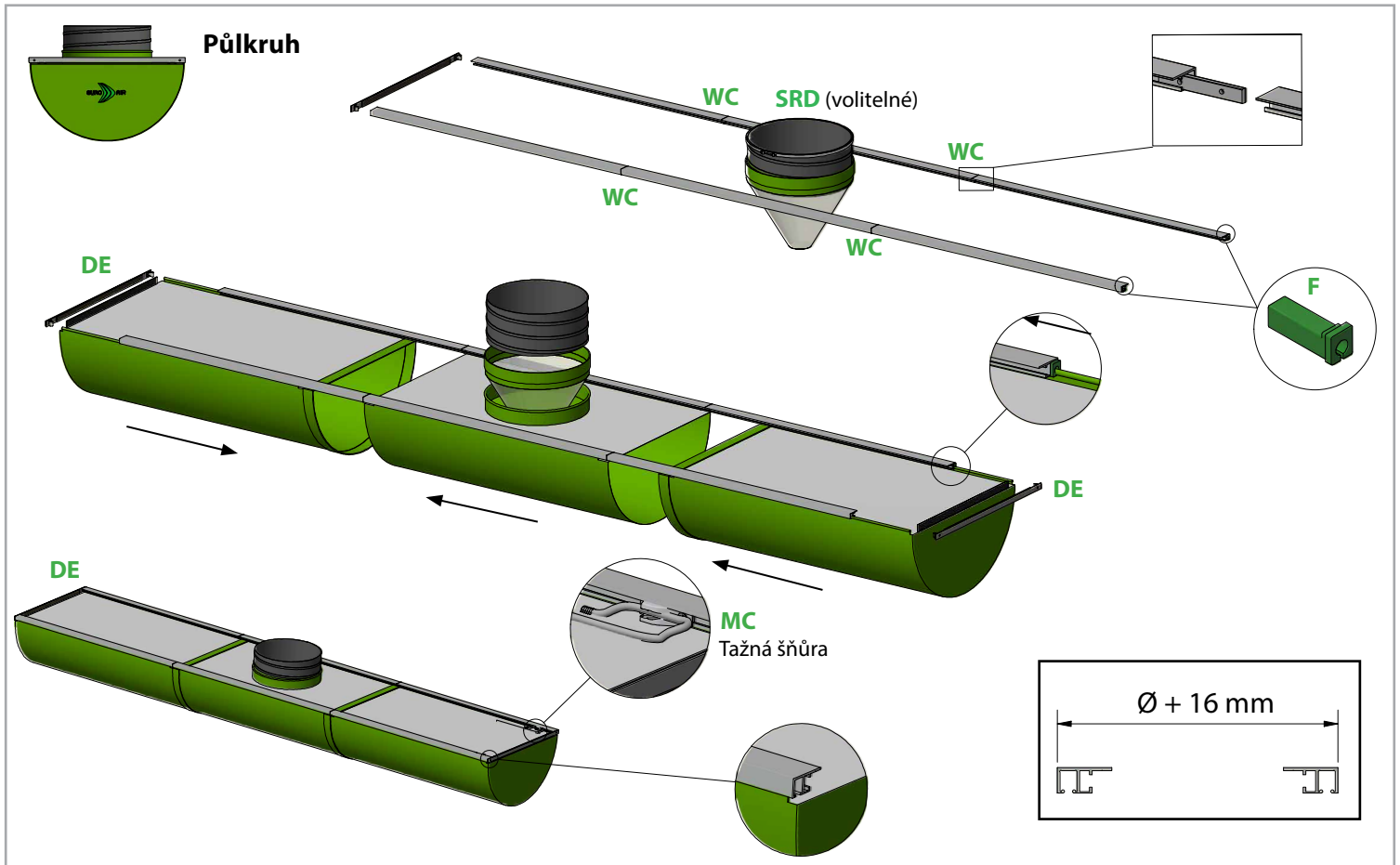

## D-Úhly

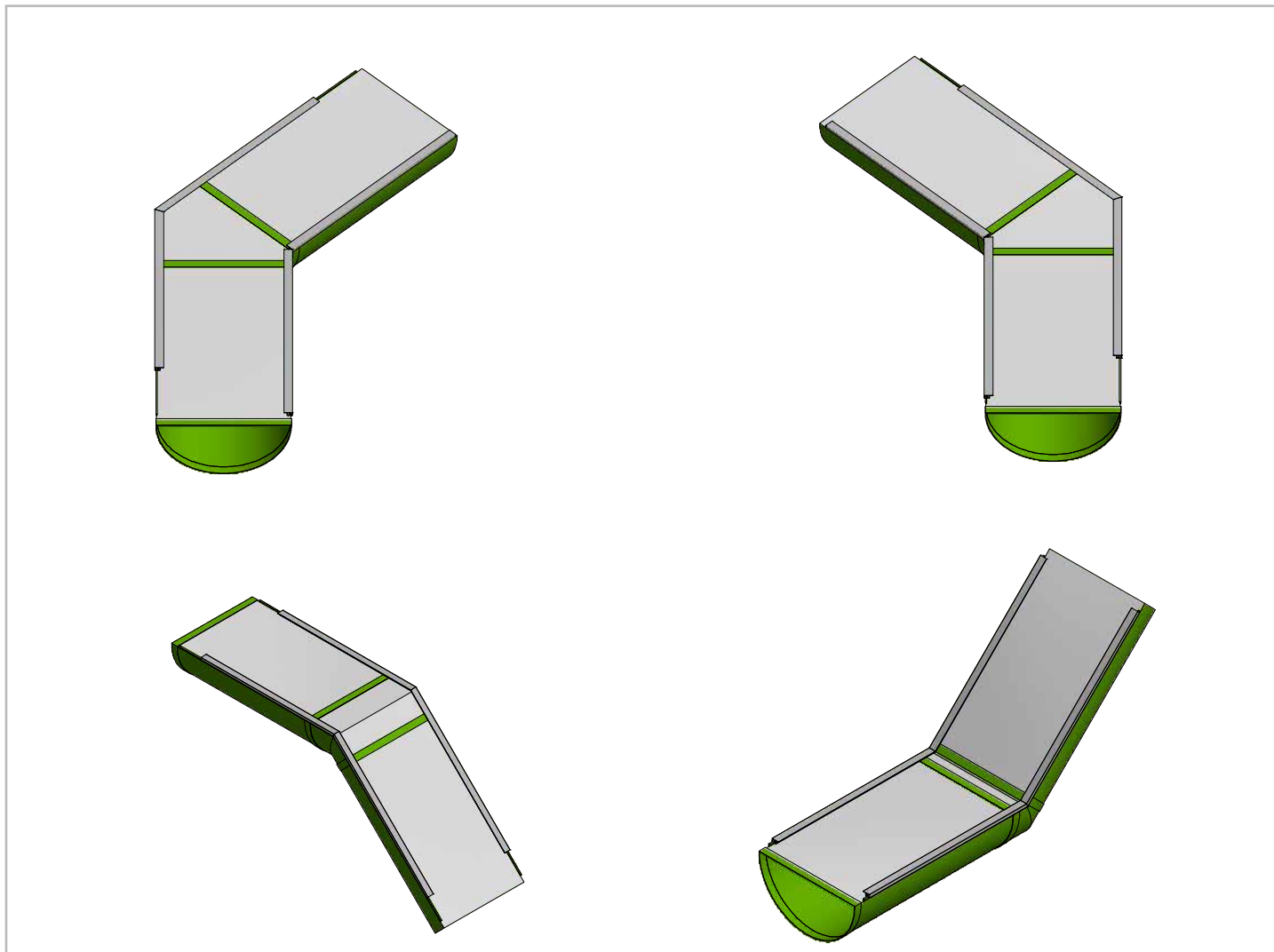

## Příklad

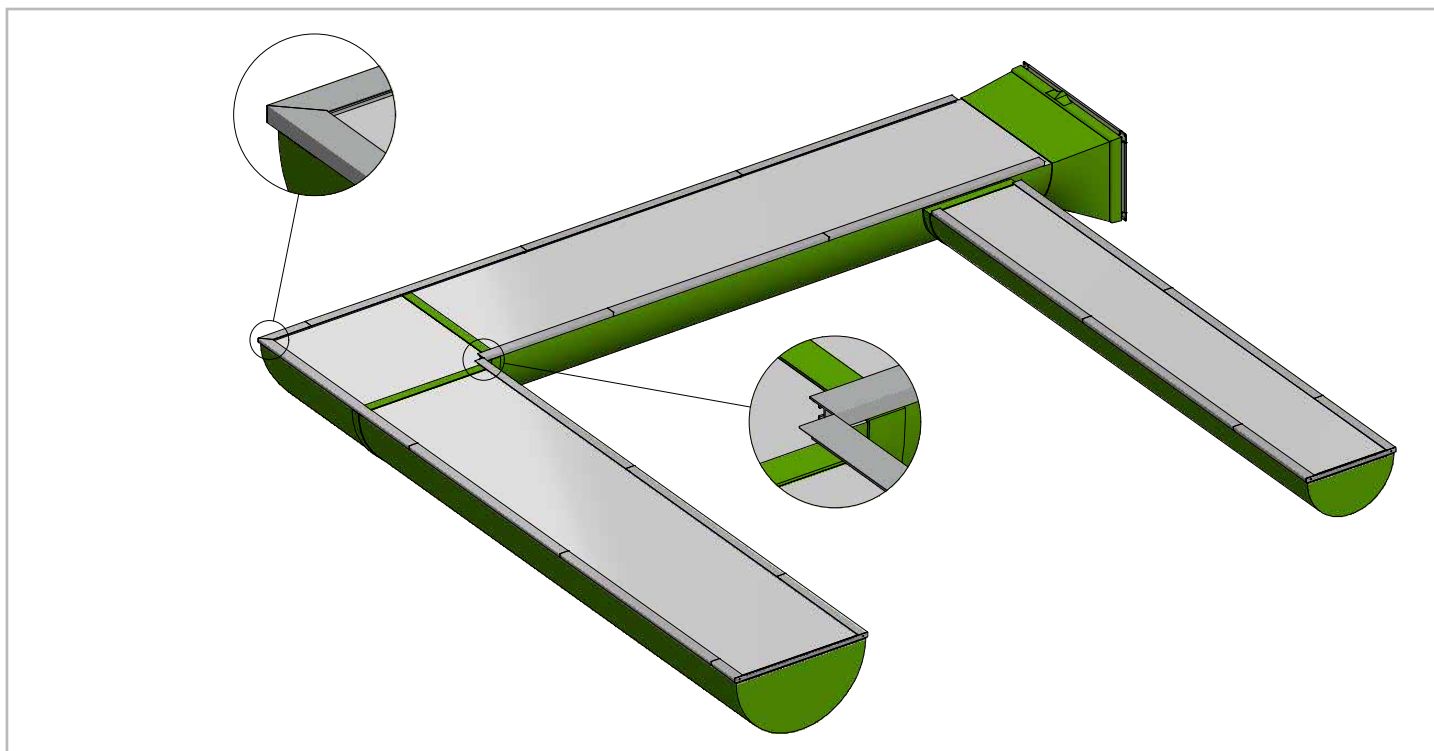

Q-Úhly

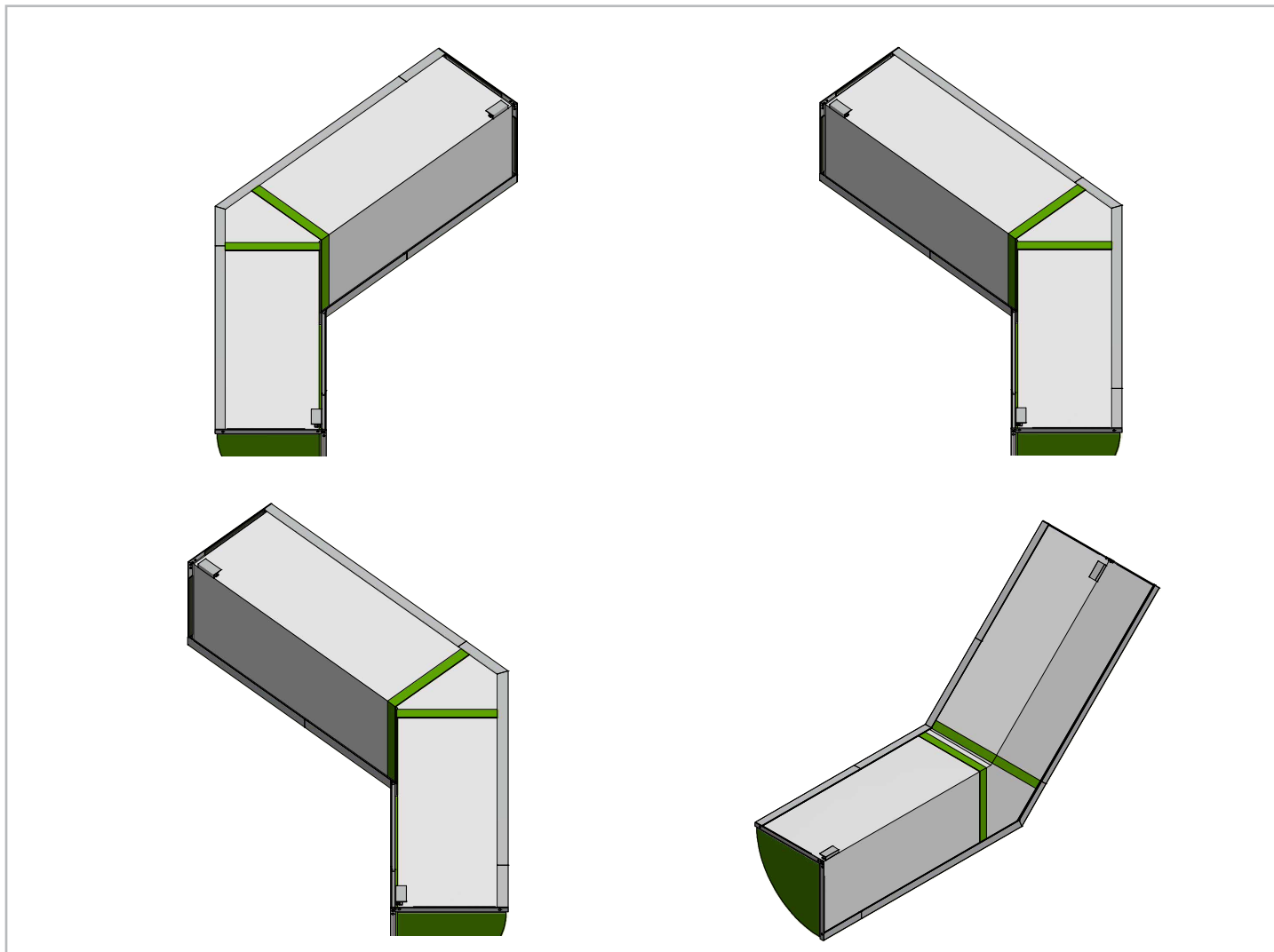

Příklad

